



NEW HOLLAND

AGRICULTURE

**ELECTRIC
PRESSURE WASHER**



BN1813E

OPERATION MANUAL

93782-LL

| | |
|----|-----------------------|
| 3 | Introduction |
| 4 | Product Information |
| 5 | Safety Rules |
| 6 | Safety Information |
| 8 | Contents |
| 9 | Unpacking & Assembly |
| 11 | Operation |
| 13 | Storage |
| 15 | Troubleshooting Chart |
| 16 | Parts list & Specs |
| 17 | Warranty |



Attention: Read through the complete manual prior to the initial use of your Pressure washer

Using the Operator's manual

The operating manual is an important part of your Pressure Washer. It should be read thoroughly before initial use and referred to often to make sure adequate safety and service concerns are being addressed.

Reading the owner's manual thoroughly will help avoid any personal injury or damage to your pump. By knowing how best to operate this machine you will be better positioned to show others who may also operate the unit.

You can refer back to the manual at any time to help troubleshoot any specific operating functions, so store it with the machine at all times.

Record Identification Numbers

Pressure washer

If you need to contact an Authorized Dealer or Customer Service line (**1-855-850-6668**) for information on servicing, always provide the product model and identification numbers.

You will need to locate the model and serial number for the pump and record the information in the places provided below.

| |
|--------------------------|
| Date of Purchase: |
| Dealer Name: |
| Dealer Phone: |

| |
|---------------------------------------|
| Product Identification Numbers |
| Model Number: |
| Serial Number: |



Save these Instructions

SAFETY RULES











This is the safety alert symbol. It is used to alert you to potential personal injury hazards. Obey all safety messages that follow this symbol to avoid possible injury or death.

The safety alert symbol () is used with a signal word (DANGER, CAUTION, WARNING), a pictorial and/or a safety message to alert you to hazards.

| |
|---|
| DANGER indicates a hazard which, if not avoided, will result in death or serious injury. |
| WARNING indicates a hazard which, if not avoided, could result in death or serious injury. |
| CAUTION indicates a hazard which, if not avoided, might result in minor or moderate injury. |
| NOTICE indicates a situation that could result in equipment damage. Follow safety messages to avoid or reduce the risk of injury or death. |

Hazard Symbols and Meanings

| | | | |
|---|---|---|---|
|  |  |  |  |
| EXPLOSION | FIRE | HOT SURFACE | MOVING PARTS |
|  |  |  |  |
| FLYING OBJECTS | ELECTRIC SHOCK | TOXIC FUMES | INJECTION |

| |
|---|
| NOTICE |
| <ul style="list-style-type: none"> • This pressure washer is equipped with a microswitch sensitive to water flow. This Total Stop System (TSS) senses water flow in the pump. When the trigger is released, water stops flowing through the pump. The TSS then automatically turns the motor off to protect the pump from overheating. |

1. **WARNING**—When using this product basic precautions should always be followed, including the following:
2. Read all the instructions before using the product.
3. Know how to stop the product and bleed pressures quickly. Be thoroughly familiar with the controls.
4. Keep operating area clear of all persons.
5. Do not overreach or stand on unstable support. Keep good footing and balance at all times.
6. Follow the maintenance instructions specified in the manual.
7. To avoid personal injury and/or damage to property and to maximize your power washing experience, carefully follow all of the safety tips, instructions, warnings and safeguards and become familiar with all of the controls. Be sure you know how to quickly bleed off the pressure from all parts of your power washer, and how to turn off the power washer.
8. This power washer conforms to CSA and other safety and consumer standards. Do not modify or rebuild any part of your power washer.
9. Do not use your power washer when you are under the influence of alcohol or drugs. Use this power tool carefully and only when you are alert .
10. Watch your balance and footing while using your power washer. Surfaces become slippery when wet and are extra slippery when using a detergent or cleaner.
11. Never operate the power washer in bare feet, sandals, or open-toed shoes.
12. When using the power washer near children make sure they are closely supervised by an adult to avoid injury. Never let a child use the power washer.
13. Keep fingers, hands, feet and any part of your body clear of the stream of high pressure water. The powerful spray can cause blindness or blast holes in the skin. It can break a window if you are too close when you pull the trigger on the spray gun.
14. Always wear eye protection to prevent injury to eyes when operating the power washer.
15. To avoid mishaps or injury, always use the trigger safety lock when not using the power washer even if the spraying stops for a moment.
16. The power washer is equipped with a Ground Fault Circuit Interrupter (GFCI) which greatly reduces the chance of electric shock while the unit is in use. If Replacement Of The Plug Or Cord Is Needed, Use Only Identical Replacement Parts.
17. Point the spray gun in a safe direction when beginning a power washing session.
18. Warning - Never spray directly at a person, animal, electrical device, or the unit itself.
19. When first using the spray gun, hold the spray gun and lance with two hands when pulling the trigger until you get used to the “kick back” from the spray gun (one hand to pull the trigger and the other to stabilize the gun assembly).
20. When you press the power switch to turn off the power washer, water pressure may remain in the system. To discharge the pressure, point the spray gun in a safe direction and pull the trigger.
21. Never spray flammable liquids.
22. Never use the pressure washer in areas that contain combustible dust, liquids, or vapors.
23. Avoid contact of the pressure hose with sharp objects and examine the hose regularly. Replace if damaged. Due to the high pressure involved, it cannot be repaired if cut or damaged.

24. Only use detergent specifically formulated for power washers and follow instructions on the detergent's label. We have a selection of power washer detergents to choose from. Go to our website for more information and to order the detergents. Power washer detergents are also available at your local hardware store.
25. Protect eyes, lungs, and skin from exposure to detergent. Dish or laundry soap is too thick and will clog the nozzle of your detergent bottle.
26. Warning - If connection is made to a potable water source, the system should be protected against back flow.
27. **IMPORTANT:** Store the power washer indoors to prevent the water in the unit from expanding under freezing conditions. When the water freezes and expands, your power washer will be damaged and become inoperable. Or, if storing outdoors, it is recommended you use Pump Saver. Pump Saver can be purchased on our website. See details in the Pump Saver section of this manual. Never use hot water with your power washer. It will overheat and damage the high pressure pump.
28. Never use hot water with your pressure washer. It will cause it to overheat and damage the high pressure pump.
29. Never leave the power washer unattended while it is powered "on".
30. Always turn the water supply "on" before turning the power washer power to "on". Running the pump dry will cause damage to the internal components.
31. Never use a water supply to your power washer that exceeds 150 psi maximum.
32. Never disconnect the high pressure hose from the power washer while the system is pressurized.
33. Never permanently engage the trigger mechanisms on the spray gun.
34. Never operate the power washer unless all components are properly and securely connected.
35. Never allow the power washer pump to run for more than one minute, after you have turned off the water supply. This can cause the motor and pump to overheat and fail.
36. Never use lances or other parts that have not been supplied with your power washer.
37. Never use an extension power cord since it defeats the effectiveness of the GFCI and increases the chance of electrocuting the operator.
38. Never spray any electrical outlet with your power washer.
39. Inspect the power cord before using. Do not use it if it is damaged.

Servicing of a Double-Insulated Appliance

GROUND FAULT CIRCUIT INTERRUPTER PROTECTION

This pressure washer is provided with a ground-fault circuit-interrupter (GFCI) built into the plugs of the power-supply cord. This device provides additional protection from the risk of electric shock. Should replacement of the plug or cord become necessary, use only identical replacement parts that include GFCI protection.

In a double-insulated product, two systems of insulation are provided instead of grounding. Grounding means are not provided for a double-insulated product, nor should grounding means be added to the product.

Servicing a double-insulated product requires extreme care and knowledge of the system, and should only be done by qualified service personnel. Replacement parts for a double-insulated product must be identical to the original parts. A double-insulated product is marked with the words "Double Insulation" or "Double Insulated". Product may also be marked with symbol shown here.

Contents

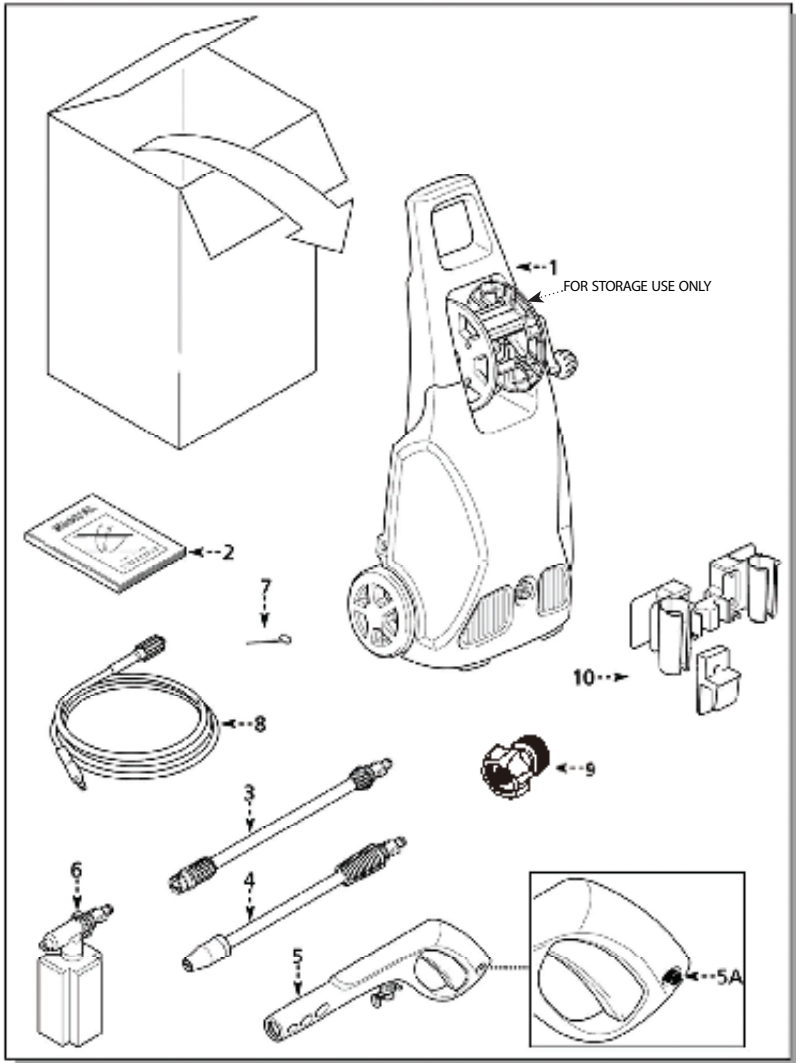

- | | |
|----------------------------------|--------------------------------|
| 1. Pressure Washer Unit | 6. Detergent Bottle |
| 2. Manual | 7. Nozzle Cleaning Tool |
| 3. Adjustable Spray Nozzle | 8. Soft PVC High-Pressure Hose |
| 4. Turbo Lance | 9. Garden Hose Adapter |
| 5. Spray Gun (5A = Trigger Lock) | 10. Accessory Holder |

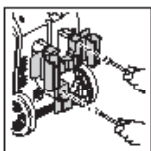

Fig. 1

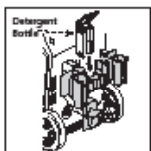

Fig. 2

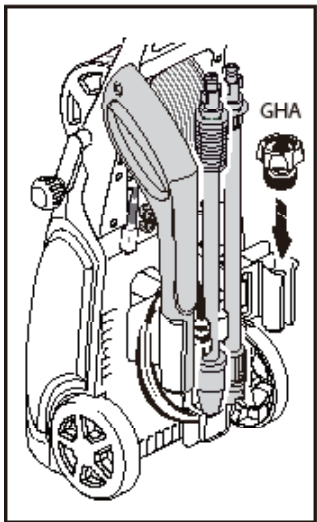

Fig. 3

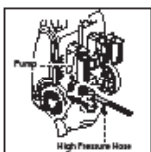

Fig. 4

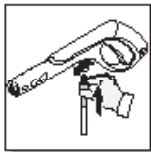

Fig. 5

- After unpacking the pressure washer, lay out the parts and accessories. Familiarize yourself with the parts in the package by comparing them to those listed on the "PACKAGE CONTENTS" page.
- The washer requires some minor assembly. You'll need a Phillips screwdriver to install the accessory holders .
- Install the accessory holder on the back of your washer (Fig. 1). You'll notice where the accessory holder meets the back of the unit. You will see posts and holes enable easy placement of the accessory holder and easy tightening of the screws. Place the screws in the holes provided on the accessory holder and screw them in. Do not use power tools, hand tighten instead.
- After installation, you will notice a square area for easy storage and retrieval of the detergent bottle (Fig.2).
- Using one of the supplied screws, install the small electric power cord holder below the accessory holder so that the "L" - shaped holder faces downward. The electric power cord can now be wrapped around the accessory holder and the bottom "L" - shaped holder while your power washer is not in use (Fig. 1).
- Please refer to (Fig. 3) for accessory storage locations on the accessory holder.

Soft PVC High Pressure Hose

- Screw the Soft PVC high pressure hose (clockwise) on the back of the unit at the bottom (Fig. 4). The end of the hose must be inserted into the water outlet far enough so the collar can thread onto the outlet threads until hand tight. Do not use pliers or vice grips to tighten. If it takes fewer than six or so turns you have not properly tightened the Soft PVC high pressure hose fitting. It is easier to position the power washer in front of you so to ensure that the threads are started correctly. Failure to properly tighten the Soft PVC high pressure hose will result in the hose slipping or popping off immediately upon turning the unit on. Do not worry about damage if this occurs -just reinstall and take extra care at screwing on the Soft PVC high pressure hose fitting.
- Connect the other end of the Soft PVC high pressure hose to the spray gun by inserting the brass metal tip of the Soft PVC high pressure hose into the fitting just ahead of the trigger guard. It will lock into the spray gun with a "click" (Fig. 5). Confirm the hose is locked into the spray gun by pulling slightly on the hose. The hose is now securely attached to the spray gun.



Fig. 6

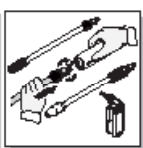

Fig. 7

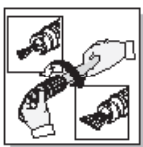

Fig. 8

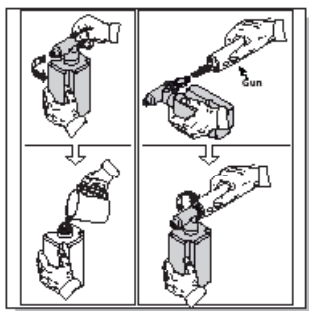

Fig. 9

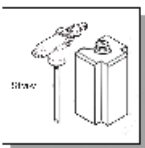

Fig. 10

- To release the hose from the spray gun, press the blue button on the underside of the gun toward the trigger guard. The hose will slide out from the connection.

Spray Gun

- To lock the trigger of the spray gun aim the gun away from you and push the lock button from right to left, (Fig. 6), after doing so, squeeze or pull the trigger to make sure it is locked and will not move. Get in the habit of leaving the lock button in the "locked" position when the power washer is not in use. This ensures the gun is in "safe" mode until it is ready for use.

Lance and Detergent Bottle

- While the spray gun is in the locked position, insert the turbo lance, the adjustable spray lance, or the detergent bottle directly into the end of the spray gun by inserting and pushing together and turning clockwise simultaneously. To remove push together and turn counter clockwise (Fig. 7). Push the safety lock button to lock the trigger when changing lances or detergent tank, to ensure that they do not accidentally eject with force during removal.

- When using the turbo lance, make sure the turbo nozzle is screwed on tight at the end of the lance, each time you use it. The Turbo lance is designed for high impact cleaning. Only use on hard surfaces such as driveways, cement surfaces, patio bricks, etc. A test strip should be done prior to avoid chance of damaging the surface.
- When using the adjustable spray lance, the spray pattern and intensity can be controlled according to power of water needed for each task by twisting the spray nozzle at the far end of the lance (Fig. 8). These can be used for sweeping leaves or debris from flat surfaces or curbing. This lance has the widest variety of applications as the fan degree allows for good impact pressure and cleaning coverage. When using the detergent bottle, fill it with a properly formulated detergent or cleaner with water ratio according to instructions on the container (Fig. 9). The detergent bottle comes with a straw which is fitted into the screw-on top. If you do not see the straw, looking inside the bottle and attach it to the screw-on top (Fig. 10).
- **NOTE:** the ratio of water to detergent is 10:1 or 10 parts water to 1 part detergent.

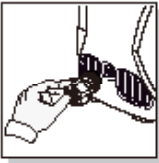

Fig.11

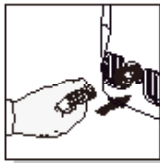

Fig.12



Fig.13

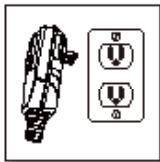

Fig.14



Fig.15



Fig.16

- Attach collar of garden hose adapter directly to power washer water inlet. Hand tighten (Fig. 11).
- Attach garden hose to the garden hose adapter (Fig. 12). Note: Flush out garden hose before connecting to garden hose adapter.
- You have now completed the assembly of your pressure washer and are now ready to begin using it. Remember to read and observe all safety instructions.

Operating Instructions

- Make sure the "ON/OFF" switch is in the "OFF" position. The power switch has international symbols for 'on' and 'off': On (→) Off (O). (Fig. 13)
- Unwind the power cord completely and plug the GFCI into a grounded 120 volt outlet. (Fig. 14).
- Turn on the water supply at the faucet.
- Release the safety lock button on spray gun (Fig. 15) while pointing the spray gun in a safe direction, away from yourself and others squeeze the trigger on the spray gun until there is a steady stream of water, letting the water and air out of the hose.
- Press the "ON" button. The motor and pump should now be running and provide a powerful spray.

Operating Tips and Maintenance

- If you hear the motor run intermittently when the trigger is not being squeezed, that is normal. The pump is priming itself so it is ready to operate when the trigger is squeezed. Turn off the power washer if not being used for more than five minutes.
- The o-rings on the bayonet end of the adjustable lance and detergent bottle should be cleaned regularly and lubricated with non-water soluble grease.
- The screen inside the clear adapter should be cleaned periodically. Insert a pen or pencil in small hole at the end of the adapter. The screen filter will slide out (Fig.16). Rinse it with clean water, and then place it back in the adapter.
- Keep the nozzle cleaning wire, Which is taped to this manual for use in unclogging the lance nozzle. If you lose the cleaning wire an unbent paper clip works fine.

Cleaning Nozzles

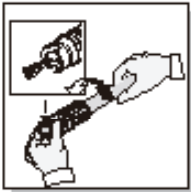

Fig. 17



Fig. 18



Fig. 19

- A clogged or partially clogged nozzle can cause significant reduction of water pressure and can cause the unit to pulse/rattle while spraying.
- Turn off the unit
- Turn off the water supply to the unit
- Relieve any pressure trapped in the hose by squeezing the trigger 2-3 times, and then lock the spray gun by pushing the lock button from left to right.
- Take off the adjustable lance. Rotate the nozzle on the adjustable lance to the narrow stream setting which opens up the fan blades (Fig. 17).
- Using the nozzle tip cleaner provided (or an unfolded paper clip), insert the wire into the nozzle hole and move back and forth until debris is dislodged (Fig. 18). Back flush water through the nozzles using garden hose and highest pressure available (either standard water nozzle or use your thumb over the nozzle to create water pressure for back flush).

How to Avoid Damaging Surfaces

- Damage to surfaces being cleaned occurs because the impact force of the water pressure exceeds the durability of the surface. Bare wood can be penetrated; paint can be peeled off, etc. You can vary the force of your power washer by controlling:
 - o the fan pattern of the nozzle (when using the adjustable nozzle)
 - o the angle of the surface being cleaned
 - o the distance of the nozzle from the surface being cleaned
- Never use a narrow high pressure stream of water or the turbo lance on soft surfaces susceptible to damage.
- Use the adjustable spray lance when cleaning windows. Be sure to adjust the nozzle to a wide fan spray pattern and place the nozzle approximately four to five feet away from the window with the nozzle at a forty-five degree angle. Squeeze the trigger and vary the fan spray pattern/angle until optimal cleaning results are achieved (Fig.19).

Detergent Bottle

- Use detergents designed for power washers. We offer four power washer detergents. They are Auto, Motorcycle, Boat and Universal. These can be purchased online at our website, hardware stores, or home centers also have power washer detergents for different cleaning projects. The cleaning solution should be the consistency of water in order to prevent clogging your detergent bottle and nozzle.

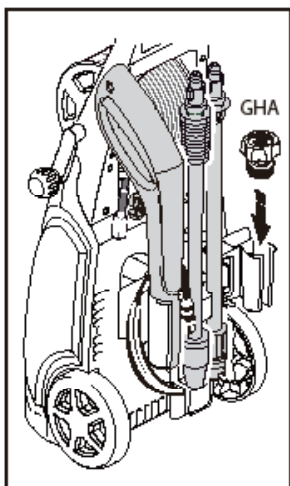

Fig. 20

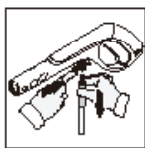

Fig. 21

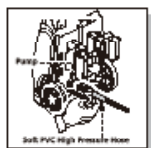

Fig. 22

- When using the detergent bottle, our power washer's application ratio of water to detergent is 10:1 or 10 parts water to 1 part detergent. You will need to adjust the concentration ratio of the detergent, according to the manufacturer's instructions.
- This system applies detergent under low pressure. The cleaning power of the detergents is enhanced when applied with low pressure; and time is allowed to break down the dirt and grime. The combination of low pressure and chemical action is very effective and can be better than scrubbing if applied properly. Always spray detergent on a dry surface, do not pre-soak area. Wetting the surface first dilutes the detergent and reduces its cleaning ability. Do not allow detergent to dry on surface. On vertical surfaces being cleaned, apply detergent to lower surfaces and work your way up to prevent detergent from causing streaks. Rinse detergent by pressure washing from bottom up for same reason.
- If a stain is particularly tough, it may be necessary to reapply the detergent and use a stiff bristled brush to scrub the stain. Subsequent power washing after brushing should successfully complete the job.

Storage

- When your pressure washing session has been completed, turn off the power switch located on the back of the power washer. Unplug the power cord from the outlet. Turn off the water supply. Pull the trigger on the spray gun 2-3 times to drain excess water and to release any remaining water pressure.
- The GHA should be stored in the accessory holder when your unit is not in use to prevent loss or damage (Fig. 20).
- Remove Soft PVC high pressure hose from spray gun (Fig. 21) and unscrew the other end of the high pressure hose from the power washer (Fig. 22).
- Remove lance or detergent bottle from the gun and place in the accessory holder. Place the gun in the accessory holder in one of the slots. Lances are pressed into and stored in the half circle notches (Fig. 20). Make sure to discard any remaining detergent from the bottle. Flush the bottle and nozzle head with fresh water to prevent clogging.
- Wrap the power cord around the accessory holder using the extension tabs at the 3:00 & 9:00 position and the L-shaped power cord holder/tab located at the 6:00 position.



Fig. 23



Fig. 24



Fig. 25

- The pressure hose is stored on the hose reel located above the accessory holder. With the front of the power washer facing towards you, insert the un-threaded end of the power hose into the square hole on the inner reel and begin turning the handle away from you (Fig. 23). After inserted into the square hole, place the hose under the indentation on the side of the reel to keep it in place while winding it up (Fig. 24). when finished winding, push the handle in to lock it in place. Please remember: the hose reel is only for storing the high pressure hose. The hose must be completely removed from the hose reel each time you use the power washer.
- **DO NOT store the power washer where it is exposed to freezing temperatures unless you use Pump Saver.** It is recommended that you use Pump Saver for storing in freezing temperatures. Freezing will damage the pump unless Pump Saver is added to the power washer. If not using or if storing your power washer for more than one month, run Pump Saver through it. See the section on Pump Saver for more information.

Pump Saver

- Pump Saver is a product that protects and prolongs the life of the pump. This will keep the internal parts of the pump lubricated and protected from freezing while being stored in ALL climates. It also assists with protection from internal corrosion.

Pump Saver Instructions

- Follow the previous storage instructions for your power washer. To prevent staining, protect the surface under the power washer from any excess fluid. Wear eye protection when using this product.
- Turn unit off and disconnect the gun before adding pump protector. Unscrew threaded top from bottle to remove seal and reattach threaded top to bottle. Remove black cap from bottle.
 - 1) Place top of pump saver bottle onto the garden hose adaptor previously installed to pressure washer inlet.
 - 2) Secure pump saver bottle by turning in a clockwise direction.
 - 3) Turn power on.
 - 4) Squeeze bottle to help it into the pump.
 - 5) Turn power off when pump saver exits the machine's water outlet.

Note: Pump Saver instructions are generic, not model specific.

| | |
|--|--|
| <p>Unit will not turn on.</p> | <p>Make sure the power washer is in the "OFF" position. Plug in the electrical cord to a grounded 120 volt outlet (no electrical extension cord should be used). If the electrical cord will not plug into your outlet, your electrical outlet is not properly grounded and should not be used.</p> |
| <p>The high pressure (HP) hose will not connect / stay connected to the spray gun. Is this a spray gun problem?</p> | <p>In most cases, the spray gun is not the problem. The problem is the rubber sleeve covering the fitting at the end of the high pressure hose. It has likely slipped up toward the metal tip. The fix: wiggle, twist and/or pull the rubber sleeve down until the entire tip is visible plus an 1/8" of the metal fitting below the tip. Now try to insert the hose tip into the spray gun. It should "click" into place and will not come out until the hose is released by pushing in the lever on the underside of the gun.</p> |
| <p>The unit is running but there is not water flow.</p> | <p>Check the water source. Unclog the nozzle on the lance. (See nozzle cleaning instructions under "Cleaning nozzles.") Or take off the lance and just spray out of the spray gun. This will indicate if the problem is with the lance.</p> |
| <p>Why is water leaking where the high pressure hose connects to the spray gun?</p> | <p>Make sure there is an o-ring at the end of the metal tip of the high pressure hose. If no o-ring is present, the connection between the hose and spray gun will leak.</p> |
| <p>I can't remove the lance from the spray gun. What should I do?</p> | <p>All lances and the detergent tank are attached and removed from the spray gun in the same manner. Insert the quick-release end of the lance/detergent bottle into the spray gun. Press the spray gun and lance together (about a 1/8") and turn clockwise. The lance will lock in place. Remove the lance by reversing this procedure. Press the spray gun and lance together and turn counter clockwise. The lance will slide out. Or, hold the spray gun and lance in an upright position with the nozzle end on the floor. Push the whole assembly straight down to loosen the connection, and then follow the removal process again. You may also spray soapy water or a lubricant in the area where the lance connects to the spray gun.</p> |
| <p>The power washer turns on for 2 seconds, shuts off, and will not turn back on. Do I have a defective unit?</p> | <p>It sounds like your power washer is working just fine. When the water is connected, the accessories are assembled properly, and the power switch is turned on, the power washer may turn on for 1 - 2 seconds to prime the pump. It automatically shuts off and waits for the spray gun trigger to be pressed. When the trigger is pressed, water starts flowing through the pump. The water sensor in the pump "senses" the moving water and automatically turns the power washer on. Or, turn the power switch to off, hold in the trigger on the spray gun, so that you have a steady stream of water. While you are holding the trigger open on the spray gun, at the same time, turn the power switch on.</p> |

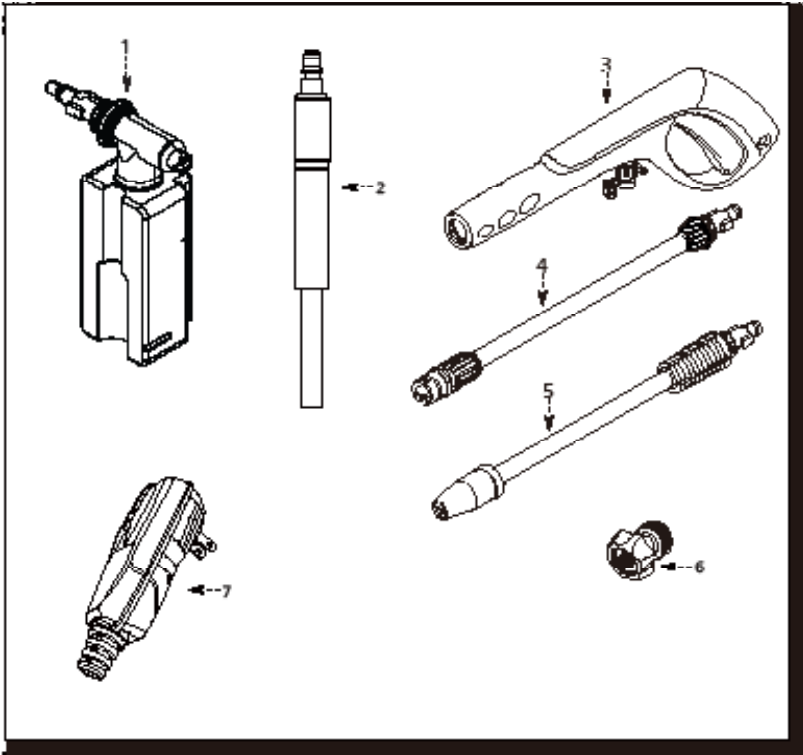

| Pos. | Description | Qty. |
|------|-------------------------|------|
| 1 | Detergent Bottle | 1 |
| 2 | Soft PVC Hose (QC) | 1 |
| 3 | Spray Gun | 1 |
| 4 | Adjustable Lance/Nozzle | 1 |
| 5 | Turbo Lance/Nozzle | 1 |
| 6 | Garden Hose Adapter | 1 |
| 7 | GFCI Assembly | 1 |

Specifications

| Model | Max PSI | Max GPM | Max Temp. | Voltage | AMPS | Unit Weight |
|---------|---------|---------|-----------------|---------|------|-------------|
| BN1813E | 1900 | 1.5 | COLD WATER ONLY | 120V | 14 | 19.5 LBS |

This product is under warranty to the original retail consumer against defects in material and workmanship for a period of 1 (one) year and is a complete “bumper to bumper” warranty including the spray gun, the high pressure hose and all accessories from the date of purchase. The warranty is not transferable or assignable. This warranty covers replacement parts. This limited one year warranty applies only to products used in consumer applications and is void in rental or any commercial application. Reasonable care must be used in conformity with operation and maintenance instructions in the owner’s manual and quick start guide. Failure to follow these instructions will void this warranty. This warranty gives you specific legal rights. You may have other rights which vary from region to region.

Keep your original receipt of purchase in case of warranty claim. Any power washer or parts returned for a warranty claim must have a “RETURNED MERCHANDISE AUTHORIZATION (RMA) NUMBER.”

You must obtain an RMA NUMBER by calling NEW HOLLAND at **1-855-850-6668** Monday through Friday, 8 a.m. to 5 p.m. (CST), or e-mail **nacustomerserviceaccount@cnhind.com**. Any return without an RMA NUMBER will be considered unauthorized and will be shipped back at the expense of the sender. Freight costs to the company for warranty work must be paid by the purchaser.

Cleaning and troubleshooting tips, manuals and other helpful information are available on our website. For parts and accessories for your NEW HOLLAND washer, visit www.cnhpowerequipment.com. Ordering is easy and all major credit cards are accepted.

NEW HOLLAND

Attn: Power Washer Warranty Department

Phone: **1-855-850-6668**

Email: **nacustomerserviceaccount@cnhind.com**

Website: **www.cnhpowerequipment.com**



NEW HOLLAND

AGRICULTURE

**If you need assistance with the
assembly or operation of this
Pressure Washer please call**

1-855-850-6668